

DK

ADVARSEL
Følgende operationer bør kun udføres på modulet i spændingsløs tilstand og under ESD-sikre forhold. Efter installation, ledningsmontage og demontering af modulet skal kun foretages af PR electronics A/S.

ADVARSEL
PR Loop Link programmeringsenheden må ikke benyttes til kommunikation med moduler installeret i Ex-område.
Enderhederne skal installeres i henhold til den tilhørende installationsvejledning ved montering i eksplosionsfarlig område.

SIKKERHEDSREGLER
Montagelse og udpakning
Udpak modulet uden at beskadige det. Kontrollér ved modtagelsen, at modultypen svarer til den bestilte. Indpakningen bør følge modulet, indtil dette er monteret på blivende plads.

Miljøforhold
Undgå direkte sollys, kraftigt støv eller varm, mekaniske tryk og støv, og udsæt ikke modulet for regn eller kraftigt fugt. Om nødvendigt skal opsætning og demontering ske inden for omgivelsetemperatur, forhindres ved hjælp af ventilation.

Installation
Modulet må kun tilsluttes af kvalificerede teknikere, som er bekendte med de tekniske udtryk, advarsler og instruktioner i installationsvejledningen og som vil følge disse.
Hvis der er tvivl om modulets rette håndtering, skal der rettes henvendelse til den lokale forhandler eller alternativt direkte til PR electronics A/S.
Installation og tilslutning af modulet skal følge landets gældende regler for installation af elektrisk materiel bl.a. med hensyn til ledningsværnsnit, forskydning og placering.
Beskrivelse af indgang / udgang og forsyningsforbindelser findes i produktmanualen, som kan hentes på www.prellectronics.dk.

Kalibrering og justering
Under kalibrering og justering skal måling og tilslutning af eksterne spændinger udføres i henhold til denne installationsvejledning, og teknikeren skal benytte sikkerhedsmæssigt korrekte værktøjer og instrumenter.

Renngøring
Modulet må, i spændingsløs tilstand, rengøres med en klud let fugtet med destilleret vand.

PC-programmering af SYSTEM 5300
Modulet konfigureres til den aktuelle opgave ved hjælp af en PC og PR electronics A/S kommunikationsinterface Loop Link. Det er muligt at konfigurere modulet både med og uden tilsluttet forsyningsspænding. Idet kommunikationsinterface leverer nødvendig forsyning til opsætningen. Kommunikationsinterface er galvanisk isoleret, så PCens port er optimalt beskyttet. Kommunikation er 2-vejs, så modulets opsætning kan hentes ind i PC'en, og opsætningen i PC'en kan sendes til modulet. For de brugere, der ikke selv vil foretage opsætning, kan modulet leveres konfigureret efter oplyst specifikation: indgangstype, måleområde, følerfejldetektering og udgangssignal.

Elektriske specifikationer

Specifikationsområde.....	-40°C til +85°C
Forsyningsspænding.....	8,0...35 VDC
5333A & 5343A.....	25 mW...0,8 W
5333A & 5343A.....	8,0...30 VDC
Forsyningsspænding.....	25 mW...0,7 W
5333D & 5343B.....	20...28°C
Kalibreringstemperatur.....	< 95% RH (ikke kond.)
Relativ fugtighed.....	Ø44 x 20,2 mm
Mål.....	IP68 / IP00
Kapslingsklasse (hus/klemme).....	

Indgangstyper:

*P1100.....	-200°C...+850°C
*N1100.....	-60°C...+250°C
Lin. R. 5333.....	0 Ω...10000 Ω
Lin. R. 5343.....	0 Ω...100 kΩ

Strømdugang:

Signalområde.....	4...20 mA
Min. signalområde.....	16 mA
Belastningsmodstand, Ω.....	≤ (Vforsyn.-8,0 V)/0,023

Overholdte myndighedskrav:

EMC.....	2014/30/EU & UK SI 2016/1091
ATEX.....	2014/34/EU & UK SI 2016/1107
RoHS.....	2011/65/EU & UK SI 2012/3032
EAC.....	TR-CU 020/2011
EAC Ex.....	TR-CU 012/2011

Godkendelser:

DNV, Ships & Offshore.....	TAA0000101
EAC Ex.....	RU C-DK.HA65.B.00355/19

* Gælder kun 5333

UK

WARNING
The following operations should only be carried out on a disconnected device and under ESD safe conditions.
General mounting, connection and disconnection of wires. Troubleshooting the device. Repair of the device must be done by PR electronics A/S only.

WARNING
Do not use the Loop Link programming interface to program the units in Ex area.
For installation in classified area the modules must be installed according to the appropriate installation drawings.

SAFETY INSTRUCTIONS
Receipt and unpacking
Unpack the device without damaging it. The packing should always follow the device until this has been permanently mounted. Check at the receipt of the device whether the type corresponds to the one ordered.

Environment
Avoid direct sunlight, dust, high temperatures, mechanical vibrations and shock, as well as rain and heavy moisture. If necessary, heating in excess of the stated limits for ambient temperatures should be avoided by way of ventilation.

Mounting
Only qualified technicians who are familiar with the technical terms, warnings, and instructions in this installation guide and who are able to follow these should connect the device. Should there be any doubt as to the correct handling of the device, please contact your local distributor or, alternatively, PR electronics A/S.
Mounting and connection of the device should comply with national legislation for mounting of electric materials, i.e. wire cross section, protective fuse, and location. Descriptions of input / output and supply connections are shown in the product manual found on www.prellectronics.com.

Calibration and adjustment
During calibration and adjustment, the measuring and connection of external voltages must be carried out according to the specifications of this installation guide. The technician must use tools and instruments that are safe to use.

Cleaning
When disconnected, the device may be cleaned with a cloth moistened with distilled water.

PC programming of SYSTEM 5300
The device is configured to the present task by way of a PC and PR electronics A/S communications interface Loop Link. The device can be configured with or without a connected supply voltage as the communications interface supplies the necessary voltage to the set-up. The communications interface is galvanically isolated to protect the PC port.
Communication is 2-way to allow the retrieval of the device set-up into the PC and to allow the transmission of the PC set-up to the device. For users who do not wish to do the set-up themselves, the device can be delivered configured according to customer specifications: input type, measurement range, sensor error detection, and output signal.

Electrical specifications

Specifications range.....	-40°C to +85°C
Supply voltage.....	8.0...35 VDC
5333A & 5343A.....	25 mW...0.8 W
5333A & 5343A.....	8.0...30 VDC
Supply voltage.....	25 mW...0.7 W
5333D & 5343B.....	20...28°C
Internal power dissipation, 5333D & 5343B.....	< 95% RH (non-cond.)
Calibration temperature.....	Ø44 x 20.2 mm
Relative humidity.....	IP68 / IP00
Dimensions.....	
Protection degree (encl./terminal).....	

Input types:

*P1100.....	-200°C...+850°C
*N1100.....	-60°C...+250°C
Lin. R. 5333.....	0 Ω...10000 Ω
Lin. R. 5343.....	0 Ω...100 kΩ

Current output:

Signal range.....	4...20 mA
Min. signal range.....	16 mA
Load resistance, Ω.....	≤ (Vsupply-8,0 V)/0,023

Observed authority requirements:

EMC.....	2014/30/EU & UK SI 2016/1091
ATEX.....	2014/34/EU & UK SI 2016/1107
RoHS.....	2011/65/EU & UK SI 2012/3032
EAC.....	TR-CU 020/2011
EAC Ex.....	TR-CU 012/2011

Approvals:

DNV, Ships & Offshore.....	TAA0000101
EAC Ex.....	RU C-DK.HA65.B.00355/19

* Only applies to 5333

FR

AVERTISSEMENT
Les opérations suivantes doivent être effectuées avec le module débranché et dans un environnement exempt de décharges électrostatiques (ESD).
montage général, raccordement et débranchement de fils et recherche de pannes sur le module.
Seule PR electronics SARL est autorisée à réparer le module.

AVERTISSEMENT
Ne pas utiliser le kit de programmation "Loop Link" en zone classée dangereuse Ex.
Pour des installations en zone classée, les modules doivent être monté conformément aux plans appropriés.

CONSIGNES DE SECURITE
Réception et déballage
Déballer le module sans l'endommager. Il est recommandé de conserver l'emballage du module tant que ce dernier n'est pas définitivement monté. A la réception du module, vérifiez que le type de module reçu correspond à celui que vous avez commandé.

Environnement
N'exposez pas votre module aux rayons directs du soleil et choisissez un endroit à humidité modérée et à l'abri de la poussière, des températures élevées, des chocs et des vibrations mécaniques et de la pluie. Le cas échéant, des systèmes de ventilation permettent d'éviter qu'une pièce soit chauffée au-delà des limites prescrites pour les températures ambiantes.

Montage
Il est conseillé de réserver le raccordement du module aux techniciens qualifiés qui connaissent les termes techniques, les avertissements et les instructions de ce guide et qui sont capables d'appliquer ces derniers.
Si vous avez un doute quelconque quant à la manipulation du module, veuillez contacter votre distributeur local. Vous pouvez également vous adresser à PR electronics SARL.
Le montage et le raccordement du module doivent être conformes à la législation nationale en vigueur pour le montage de matériaux électriques, par exemple, diamètres des fils, fusibles de protection et implantation des modules. Les connexions des alimentations et des entrées / sorties sont décrites dans le manuel du produit sur www.prellectronics.fr.

Etalonnage et réglage
Lors des opérations d'étalonnage et de réglage, il convient d'éviter les mesures et les connexions des tensions externes en respectant les spécifications mentionnées dans ce guide. Les techniciens doivent utiliser des outils et des instruments pouvant être manipulés en toute sécurité.

Maintenance et entretien
Une fois le module hors tension, prenez un chiffon imbibé d'eau distillée pour le nettoyer.

Programmation par PC du SYSTÈME 5300
Le module peut être programmé en fonction d'une application donnée à partir d'un PC et le kit de programmation Loop Link de PR electronics A/S. Le module peut être programmé sans être alimenté car l'interface de communication fournit l'alimentation nécessaire pour la configuration. L'interface de communication est dotée d'une isolation galvanique pour protéger le port du PC. La communication est bidirectionnelle. Cela permet non seulement la programmation du module mais également la récupération d'une configuration existante ainsi que la lecture du numéro de série et du repère. Le module peut être livré déjà programmé, si l'utilisateur le souhaite.

Spécifications

Plage de température.....	-40°C à +85°C
Tension d'alimentation, 5333A & 5343A.....	8,0...35 Vcc
Puissance dissipée, 5333A & 5343A.....	25 mW...0,8 W
5333D & 5343B.....	8,0...30 Vcc
Tension d'alimentation, 5333D & 5343B.....	25 mW...0,7 W
Puissance dissipée, 5333D & 5343B.....	20...28°C
Température d'étalonnage.....	< 95% HR (sans cond.)
Humidité relative.....	Ø44 x 20,2 mm
Dimensions.....	IP68 / IP00
Degré de protection (boîtier/bornier).....	

Types d'entrée:

*P1100.....	-200°C...+850°C
*N1100.....	-60°C...+250°C
Lin. R. 5333.....	0 Ω...10000 Ω
Lin. R. 5343.....	0 Ω...100 kΩ

Sortie courant:

Gamme de signal.....	4...20 mA
Plage de signal min.....	16 mA
Résistance de charge, Ω.....	≤ (Vvalim.-8,0 V)/0,023

Compatibilité avec les normes:

CEM.....	2014/30/UE & UK SI 2016/1091
ATEX.....	2014/34/EU & UK SI 2016/1107
RoHS.....	2011/65/UE & UK SI 2012/3032
EAC.....	TR-CU 020/2011
EAC Ex.....	TR-CU 012/2011

Approbations:

DNV, Ships & Offshore.....	TAA0000101
EAC Ex.....	RU C-DK.HA65.B.00355/19

* Uniquement applicable pour 5333

DE

WARNUNG
Folgende Maßnahmen sollten nur in spannungslosem Zustand des Gerätes und unter ESD-sicheren Verhältnisse durchgeführt werden: Installation, Montage und Demontage von Leitungen, Fehleruche im Gerät, und Reparaturen des Gerätes dürfen nur von PR electronics A/S vorgenommen werden.

WARNUNG
Benutzen Sie die Programmierschnittstelle Loop Link nicht im Ex Bereich.
Zur Montage in klassifizierten Zonen müssen die Geräte nach den dazugehörigen Einbauezeichnungen installiert werden.

SICHERHEITSREGELN
Empfang und Auspacken
Packen Sie das Gerät aus, ohne es zu beschädigen, und kontrollieren Sie beim Empfang, ob der Gerätetyp Ihrer Bestellung entspricht. Die Verpackung sollte beim Gerät bleiben, bis dieses am endgültigen Platz montiert ist.

Umgebungsbedingungen
Direkte Sonneneinstrahlung, starke Staubentwicklung oder Hitze, mechanische Erschütterungen und Stöße sind zu vermeiden das Gerät darf nicht Regen oder starker Feuchtigkeit ausgesetzt werden. Bei Bedarf muss eine Erwärmung, welche die angegebenen Grenzen für die Umgebungstemperatur überschreitet, mit Hilfe eines Kühlgebläses verhindert werden.

Installation
Das Gerät darf nur von qualifizierten Technikern angeschlossen werden, die mit den technischen Ausdrücken, Warnungen und Anweisungen in dieser Installationsanleitung vertraut sind und diese befolgen.
Sollten Zweifel bezüglich der richtigen Handhabung des Gerätes bestehen, sollte man mit dem Händler vor Ort Kontakt aufnehmen. Sie können aber auch direkt mit PR electronics GmbH Kontakt aufnehmen.
Die Installation und der Anschluss des Gerätes haben in Übereinstimmung mit dem geltenden Regeln des jeweiligen Landes bez. der Installation elektrischer Apparaturen zu erfolgen, u.a. bezüglich Leitungsquerschnitt, (elektrischer) Vor-Absicherung und Positionierung.
Eine Beschreibung von Eingangs- / Ausgangs- und Versorgungsanschlüssen befindet sich im Produkthandbuch, das unter www.prellectronics.de gefunden und abgerufen werden kann.

Kalibrierung und Justierung
Während der Kalibrierung und Justierung sind die Messung und der Anschluss externer Spannungen entsprechend dieser Installationsanleitung auszuführen, und der Techniker muss hierbei sicherheitsmäßig einwandfreie Werkzeuge und Instrumente benutzen.

Reinigung
Das Gerät darf in spannungslosem Zustand mit einem Lappen gereinigt werden, der mit destilliertem Wasser leicht angefeuchtet ist.

PC-Programmierung des Systems 5300
Das Gerät wird für die jeweilige Aufgabe mit Hilfe eines PCs und PR electronics A/S Kommunikationsschnittstelle Loop Link konfiguriert. Es ist möglich, das Gerät sowohl mit als auch ohne angeschlossene Versorgungsspannung zu konfigurieren, da die Kommunikationsschnittstelle die notwendige Versorgung für die Einstellung liefert. Die Kommunikationsschnittstelle ist galvanisch isoliert, sodass der Anschluss des PCs optimal geschützt ist.
Die Kommunikation erfolgt in beiden Richtungen, sodass die Einstellung des Gerätes in den PC geholt, und die Einstellung im PC an das Gerät gesandt werden kann. Für diejenigen Anwender, welche die Einstellung nicht selbst vornehmen wollen, kann das Gerät nach folgenden Kundenspezifikationen konfiguriert geliefert werden: Eingangstyp, Messbereich, Fehlerleerererkennung und Ausgangssignal.

Elektrische Daten

Spezifikationsbereich.....	-40°C bis +85°C
Versorgungsspannung, 5333A & 5343A.....	8,0...35 VDC
Verlustleistung, 5333A & 5343A.....	25 mW...0,8 W
Versorgungsspannung, 5333D & 5343B.....	8,0...30 VDC
Verlustleistung, 5333D & 5343B.....	25 mW...0,7 W
Kalibreringstemperatur.....	20...28°C
Luftfeuchtigkeit.....	< 95% RF (nicht kond.)
Maß.....	Ø44 x 20,2 mm
Schutzart (Gehäuse / Anschluss).....	IP68 / IP00

Eingangs-Typen:

*P1100.....	-200°C...+850°C
*N1100.....	-60°C...+250°C
Lin. R. 5333.....	0 Ω...10000 Ω
Lin. R. 5343.....	0 Ω...100 kΩ

Stromausgang:

Signalbereich.....	4...20 mA
Min. Signalbereich.....	16 mA
Belastungswiderstand, Ω.....	≤ (VVersor.-8,0 V)/0,023

Eingehaltene Behördenvorschriften:

EMV.....	2014/30/EU & UK SI 2016/1091
ATEX.....	2014/34/EU & UK SI 2016/1107
RoHS.....	2011/65/EU & UK SI 2012/3032
EAC.....	TR-CU 020/2011
EAC Ex.....	TR-CU 012/2011

Zulassungen:

DNV, Ships & Offshore.....	TAA0000101
EAC Ex.....	RU C-DK.HA65.B.00355/19

* Gilt nur für 5333

5333A, 5333D, 5343A & 5343B

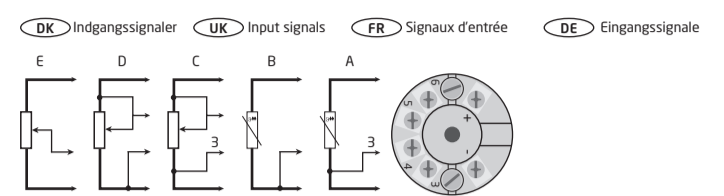

	DK	UK	FR	DE	5333	5343
A	RTD, 3-leder	RTD, 3-wire	RTD, 3-fils	WTH, 3-Letter	x	
B	RTD, 2-leder	RTD, 2-wire	RTD, 2-fils	WTH, 2-Letter	x	
C	Modstand, 3-leder	Resistance, 3-wire	Résistance, 3-fils	Widerstand, 3-Letter	x	x
D	Modstand, 2-leder	Resistance, 2-wire	Résistance, 2-fils	Widerstand, 2-Letter	x	x
E	Potentiometer, 3-leder	Potentiometer, 3-wire	Potentiomètre, 3-fils	Potentiometer, 3-Letter		x

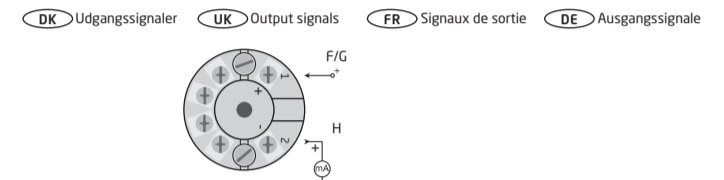

	DK	UK	FR	DE	5333A	5333D	5343A	5343B
F	Forsyning +8,0...35 VDC	Supply +8,0...35 VDC	Alimentation +8,0...35 Vcc	Versorgung +8,0...35 VDC	x		x	
G	Forsyning +8,0...30 VDC	Supply +8,0...30 VDC	Alimentation +8,0...30 Vcc	Versorgung +8,0...30 VDC		x		x
H	4...20 mA udgang	4...20 mA output	Sortie 4...20 mA	4...20 mA-Ausgang	x	x	x	x

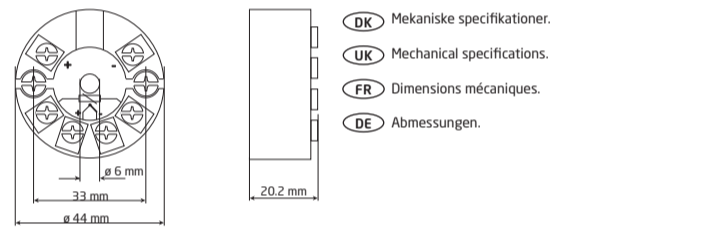
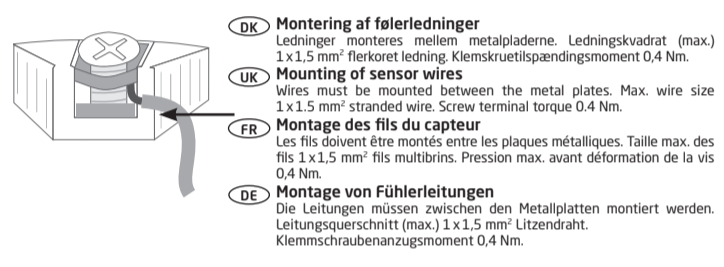

- DK** Dokumentation, godkendelser og yderligere information findes på internettet på www.prellectronics.dk
- UK** Documentation, permits and other information can be found on the internet at www.prellectronics.com
- FR** La documentation et toute autre information peuvent être trouvées sur l'Internet sur notre site: www.prellectronics.fr
- DE** Dokumentationen, Zulassungen und andere Informationen können auf unserer Internet-Seite unter www.prellectronics.de gefunden und abgerufen werden.
- BR** Documentações, licenças e outras informações podem ser encontradas no site www.prellectronics.com

- DK** Godkendelser
- UK** Approvals
- FR** Approbations
- DE** Zulassungen
- BR** Aprovações

DK	ATEX	Area / Zone	Installation drawing	IECEX	Area / Zone	Installation drawing	FM	Zone / Div.	Installation drawing	CSA	Zone / Div.	Installation drawing	INMETRO	Area	Installation drawing
5333A	DEKRA 20ATEX0106 X	2, 22	5333QA02	DEK 20.0062X	2, 22	5333QI02			1125003	2 / Div 2	5333QC02	DEKRA 23.0010 X	2, 22	5333QB02	
5343A	DEKRA 20ATEX0106 X	2, 22	5343QA02	DEK 20.0062X	2, 22	5343QI02								5333QB02	
5333D	DEKRA 20ATEX0105 X	0, 1, 2, 21, 22, M1	5333QA01	DEK 20.0062X	0, 1, 2, 21, 22, M1	5333QI01	FM17US0013X	0, 1, 2 / Div 1, 2	5300Q502	1125003	0, 1, 2 / Div 1, 2	5333QC03	DEKRA 23.0010 X	0, 1, 2, 21, 22, M1	5333QB01
5343B	DEKRA 20ATEX0105 X	0, 1, 2, 21, 22, M1	5343QA01	DEK 20.0062X	0, 1, 2, 21, 22, M1	5343QI01	FM17US0013X	0, 1, 2 / Div 1, 2	5300Q502				DEKRA 23.0010 X	0, 1, 2, 21, 22, M1	5333QB01

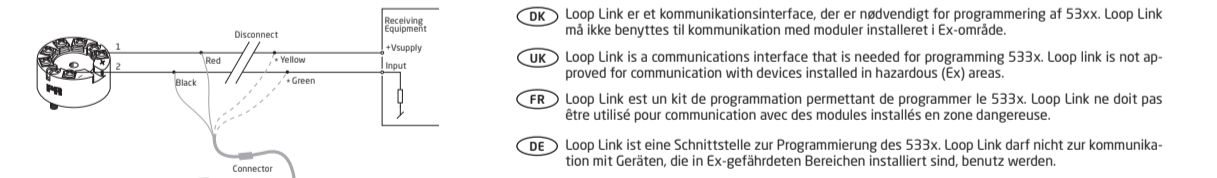

DK Loop Link er et kommunikationsinterface, der er nødvendigt for programmering af 53xx. Loop Link må ikke benyttes til kommunikation med moduler installeret i Ex-område.
UK Loop Link is a communications interface that is needed for programming 53xx. Loop link is not approved for communication with devices installed in hazardous (Ex) areas.
FR Loop Link est un kit de programmation permettant de programmer le 53xx. Loop Link ne doit pas être utilisé pour communication avec des modules installés en zone dangereuse.
DE Loop Link ist eine Schnittstelle zur Programmierung des 53xx. Loop Link darf nicht zur Kommunikation mit Geräten, die in Ex-gefährdeten Bereichen installiert sind, benutzt werden.

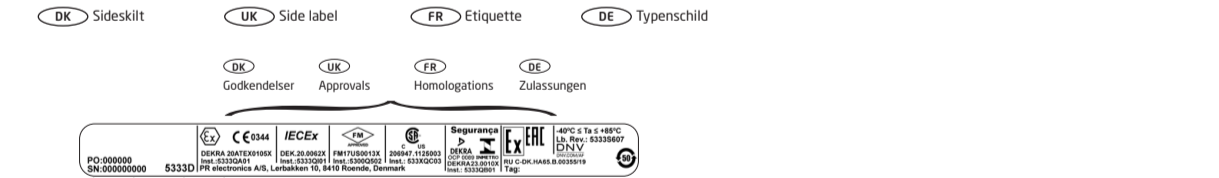

DK Sideskilt
UK Side label
FR Etiquette
DE Typenschild

DK Godkendelser
UK Approvals
FR Homologations
DE Zulassungen

PO:000000 SN:00000000 5333D
 DEKRA 20ATEX0106 X (5333A)
 DEK 20.0062X
 PR electronics A/S, Lerbakken 10, 8410 Rønde, Danmark
 DEKRA 20ATEX0105 X (5333D)
 DEK 20.0062X
 PR electronics A/S, Lerbak

ATEX-installation drawing 5333QA01-V3R0

For safe installation of 5333D the following must be observed. The module shall only be installed by qualified personnel who are familiar with the national and international laws, directives and standards that apply to this area. Year of manufacture can be taken from the first two digits in the serial number.

ATEX Certificate	DEKRA 20ATEX0105 X
Marking	II 1 G Ex ia IIC T6 ... T4 Ga II 2 D Ex ia IIC Dc I M1 Ex ia I Ma
Standards	EN 60079-0: 2018, EN 60079-11: 2012

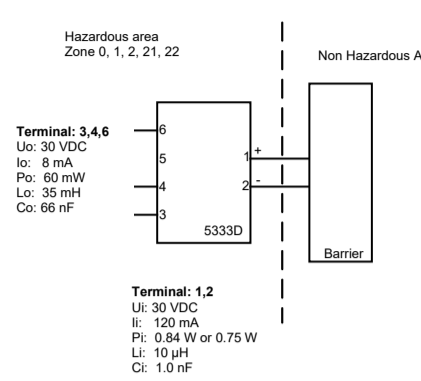

Temperature Class	Ambient temperature range	
	PI: 0.84 W	PI: 0.75 W
T6	-40°C to +47°C	-40°C to +50°C
T5	-40°C to +62°C	-40°C to +65°C
T4	-40°C to +85°C	-40°C to +85°C

Installation notes
If the enclosure is made of non-metallic plastic materials, electrostatic charges on the transmitter enclosure shall be avoided.
If the transmitter is installed in an explosive atmosphere requiring the use of equipment protection level Ga, the transmitter shall be mounted in an enclosure that provides a degree of protection of at least IP20 according to EN 60529, and that is suitable for the application and correctly installed.

If the transmitter is installed in an explosive atmosphere requiring the use of equipment protection level Ga or Ma, and if the enclosure is made of aluminum, it must be installed such that ignition sources due to impact and friction sparks are excluded.
If the transmitter is installed in an explosive atmosphere requiring the use of equipment protection level Db, the transmitter shall be mounted in a separately certified enclosure that provides a degree of protection of at least IP5X according to EN 60079-0, and that is suitable for the application and correctly installed. The surface temperature of the outer enclosure is +20 K above the ambient temperature, determined without a dust layer. Ambient temperature range: -40°C to +85°C.

If the transmitter is installed in an explosive atmosphere requiring the use of equipment protection level Ma, the transmitter shall be mounted in an enclosure that provides a degree of protection of at least IP54 according to EN 60529, and that is suitable for the application and correctly installed. Ambient temperature range: -40°C to +85°C.
Cable entries and blanking elements shall be used that are suitable for the application and correctly installed.
For an ambient temperature ≥ 60°C, heat resistant cables shall be used with a rating of at least 20 K above the ambient temperature.

Temperature Class	Ambient temperature range	
	PI: 0.84 W	PI: 0.75 W
T6	-40°C to +47°C	-40°C to +50°C
T5	-40°C to +62°C	-40°C to +65°C
T4	-40°C to +85°C	-40°C to +85°C

Installation notes
If the enclosure is made of non-metallic plastic materials, electrostatic charges on the transmitter enclosure shall be avoided.
If the transmitter is installed in an explosive atmosphere requiring the use of equipment protection level Ga, the transmitter shall be mounted in an enclosure that provides a degree of protection of at least IP20 according to IEC 60529, and that is suitable for the application and correctly installed.

If the transmitter is installed in an explosive atmosphere requiring the use of equipment protection level Ga or Ma, and if the enclosure is made of aluminum, it must be installed such that ignition sources due to impact and friction sparks are excluded.
If the transmitter is installed in an explosive atmosphere requiring the use of equipment protection level Db, the transmitter shall be mounted in a separately certified enclosure that provides a degree of protection of at least IP5X according to IEC 60079-0, and that is suitable for the application and correctly installed. The surface temperature of the outer enclosure is +20 K above the ambient temperature, determined without a dust layer. Ambient temperature range: -40°C to +85°C.

If the transmitter is installed in an explosive atmosphere requiring the use of equipment protection level Ma, the transmitter shall be mounted in an enclosure that provides a degree of protection of at least IP54 according to IEC 60529, and that is suitable for the application and correctly installed. Ambient temperature range: -40°C to +85°C.
Cable entries and blanking elements shall be used that are suitable for the application and correctly installed.
For an ambient temperature ≥ 60°C, heat resistant cables shall be used with a rating of at least 20 K above the ambient temperature.

ATEX-installation drawing 5333QA02-V3R0

For safe installation of 5333A the following must be observed. The module shall only be installed by qualified personnel who are familiar with the national and international laws, directives and standards that apply to this area. Year of manufacture can be taken from the first two digits in the serial number.

ATEX Certificate	DEKRA 20ATEX0106 X
Marking	II 3 G Ex na [c] IIC T6 ... T4 Gc II 3 G Ex ec [c] IIC T6 ... T4 Gc II 3 G Ex ic IIC T6 ... T4 Gc II 3 D Ex ic IIC Dc
Standards	EN 60079-0: 2018, EN 60079-11: 2012, EN 60079-15: 2010, EN 60079-7:2015 +A1: 2018

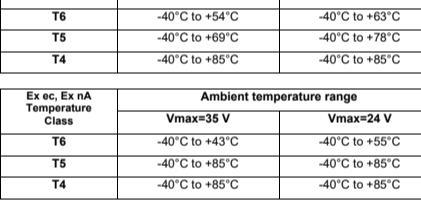

Ex ic IIC, Ex ic IIC Temperature Class	Ambient temperature range	
	Uj=35 V	Uj=24 V
T6	-40°C to +54°C	-40°C to +63°C
T5	-40°C to +69°C	-40°C to +78°C
T4	-40°C to +85°C	-40°C to +85°C

Installation notes
If the enclosure is made of non-metallic plastic materials, electrostatic charges on the transmitter enclosure shall be avoided.
If the transmitter is installed in an explosive atmosphere requiring the use of equipment protection level Gc and applied in type of protection Ex ic, the transmitter shall be mounted in an enclosure that provides a degree of protection of at least IP20 according to EN 60529, and that is suitable for the application and correctly installed.

If the transmitter is installed in an explosive atmosphere requiring the use of equipment protection level Dc, the transmitter shall be mounted in a separately certified enclosure that provides a degree of protection of at least IP5X according to EN 60079-0, and that is suitable for the application and correctly installed. The surface temperature of the outer enclosure is +20 K above the ambient temperature, determined without a dust layer. Ambient temperature range: -40°C to +85°C.

If the transmitter is installed in an explosive atmosphere requiring the use of equipment protection level Gc and applied in type of protection Ex na or Ex ec, the transmitter shall be mounted in a separately certified enclosure that provides a degree of protection of at least IP54 according to EN 60079-0, and that is suitable for the application and correctly installed.
If the transmitter is installed in an explosive atmosphere requiring the use of equipment protection level Gc and applied in type of protection Ex na or Ex ec, the equipment shall only be used in an area of not more than pollution degree 2, as defined in EN 60664-1.

CSA Installation drawing 5333QC03 – V5R0

For safe installation of the 5333D the following must be observed. The module shall only be installed by qualified personnel who are familiar with the national and international laws, directives and standards that apply to this area.

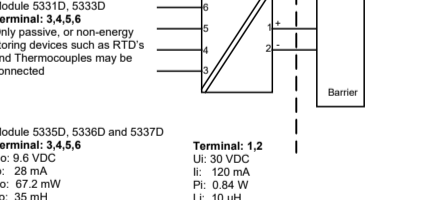

Ex ic IIC, Ex ic IIC Temperature Class	Ambient temperature range	
	Uj=35 V	Uj=24 V
T6	-40°C to +54°C	-40°C to +63°C
T5	-40°C to +69°C	-40°C to +78°C
T4	-40°C to +85°C	-40°C to +85°C

Installation instructions
The transmitter must be installed in an enclosure providing a degree of protection of at least IP54 according to IEC60529 that is suitable for the application and is correctly installed. Cable entry devices and blanking elements shall fulfill the same requirements.
If the enclosure is made of non-metallic materials or of painted metal, electrostatic charging shall be avoided.
Use supply wires with a rating of at least 5 K above the ambient temperature. Supply from a Class 2 Power Supply with Transient protection or equivalent.
WARNING: Substitution of components may impair suitability for Class 1 Division 2.
AVERTISSEMENT: La substitution de composants peut nuire à l'aptitude à la Classe 1, Division 2.
WARNING: Do not disconnect equipment unless power has been switched off or the area is known to be safe.
AVERTISSEMENT: Ne débranchez pas l'équipement sauf si l'alimentation a été coupée ou si la zone est connue pour être sûre.

Non Incendive field wiring installation
The non incandive field Wiring Circuit concept allows interconnection of Nonincendive Field wiring Apparatus with Associated Nonincendive Field Wiring Apparatus or Associated Intrinsically Safe Apparatus or Associated Apparatus not specially examined in combination as a system using any of the wiring methods permitted for unclassified locations.
Voc < Vmax, Ca ≥ Ci + Ccable, La ≥ Li + Lcable.

Part Name	Hazardous Substances				
	Lead (Pb)	Mercury (Hg)	Cadmium (Cd)	Hexavalent Chromium (Cr (VI))	Polybrominated diphenyl ethers (PBDE)
Printed circuit board	X	0	0	0	0

This table is prepared in accordance with the provisions of 5/17 11364
0: Indicates that said hazardous substance contained in all of the homogeneous materials for this part is below the limit requirement of GB/T 26572.
X: Indicates that said hazardous substance contained in at least one of the homogeneous materials used for this part is above the limit requirement of GB/T 26572.

The product's Environmentally Friendly Use Period (EFUP) is 50 years

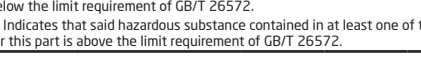

Product's Environmentally Friendly Use Period (EFUP) is 50 years

Product's Environmentally Friendly Use Period (EFUP) is 50 years

Product's Environmentally Friendly Use Period (EFUP) is 50 years

Product's Environmentally Friendly Use Period (EFUP) is 50 years

Product's Environmentally Friendly Use Period (EFUP) is 50 years

Product's Environmentally Friendly Use Period (EFUP) is 50 years

Product's Environmentally Friendly Use Period (EFUP) is 50 years

Product's Environmentally Friendly Use Period (EFUP) is 50 years

Product's Environmentally Friendly Use Period (EFUP) is 50 years

Product's Environmentally Friendly Use Period (EFUP) is 50 years

Product's Environmentally Friendly Use Period (EFUP) is 50 years

Product's Environmentally Friendly Use Period (EFUP) is 50 years

Product's Environmentally Friendly Use Period (EFUP) is 50 years

Product's Environmentally Friendly Use Period (EFUP) is 50 years

Product's Environmentally Friendly Use Period (EFUP) is 50 years

Product's Environmentally Friendly Use Period (EFUP) is 50 years

Product's Environmentally Friendly Use Period (EFUP) is 50 years

Product's Environmentally Friendly Use Period (EFUP) is 50 years

Product's Environmentally Friendly Use Period (EFUP) is 50 years

Product's Environmentally Friendly Use Period (EFUP) is 50 years

Product's Environmentally Friendly Use Period (EFUP) is 50 years

Product's Environmentally Friendly Use Period (EFUP) is 50 years

Product's Environmentally Friendly Use Period (EFUP) is 50 years

Product's Environmentally Friendly Use Period (EFUP) is 50 years

Product's Environmentally Friendly Use Period (EFUP) is 50 years

Product's Environmentally Friendly Use Period (EFUP) is 50 years

Product's Environmentally Friendly Use Period (EFUP) is 50 years

Product's Environmentally Friendly Use Period (EFUP) is 50 years

Product's Environmentally Friendly Use Period (EFUP) is 50 years

Product's Environmentally Friendly Use Period (EFUP) is 50 years

Product's Environmentally Friendly Use Period (EFUP) is 50 years

Product's Environmentally Friendly Use Period (EFUP) is 50 years

Product's Environmentally Friendly Use Period (EFUP) is 50 years

Product's Environmentally Friendly Use Period (EFUP) is 50 years

Product's Environmentally Friendly Use Period (EFUP) is 50 years

Product's Environmentally Friendly Use Period (EFUP) is 50 years

Product's Environmentally Friendly Use Period (EFUP) is 50 years

Product's Environmentally Friendly Use Period (EFUP) is 50 years

Product's Environmentally Friendly Use Period (EFUP) is 50 years

Product's Environmentally Friendly Use Period (EFUP) is 50 years

Product's Environmentally Friendly Use Period (EFUP) is 50 years

Product's Environmentally Friendly Use Period (EFUP) is 50 years

Product's Environmentally Friendly Use Period (EFUP) is 50 years

Product's Environmentally Friendly Use Period (EFUP) is 50 years

Product's Environmentally Friendly Use Period (EFUP) is 50 years

Product's Environmentally Friendly Use Period (EFUP) is 50 years

Product's Environmentally Friendly Use Period (EFUP) is 50 years

Product's Environmentally Friendly Use Period (EFUP) is 50 years

Product's Environmentally Friendly Use Period (EFUP) is 50 years

Product's Environmentally Friendly Use Period (EFUP) is 50 years

Product's Environmentally Friendly Use Period (EFUP) is 50 years

Product's Environmentally Friendly Use Period (EFUP) is 50 years

Product's Environmentally Friendly Use Period (EFUP) is 50 years

Product's Environmentally Friendly Use Period (EFUP) is 50 years

Product's Environmentally Friendly Use Period (EFUP) is 50 years

Product's Environmentally Friendly Use Period (EFUP) is 50 years

Product's Environmentally Friendly Use Period (EFUP) is 50 years

Product's Environmentally Friendly Use Period (EFUP) is 50 years

Product's Environmentally Friendly Use Period (EFUP) is 50 years

Product's Environmentally Friendly Use Period (EFUP) is 50 years

Product's Environmentally Friendly Use Period (EFUP) is 50 years

Product's Environmentally Friendly Use Period (EFUP) is 50 years

Product's Environmentally Friendly Use Period (EFUP) is 50 years

Product's Environmentally Friendly Use Period (EFUP) is 50 years

Product's Environmentally Friendly Use Period (EFUP) is 50 years

Product's Environmentally Friendly Use Period (EFUP) is 50 years

Product's Environmentally Friendly Use Period (EFUP) is 50 years

Product's Environmentally Friendly Use Period (EFUP) is 50 years

Product's Environmentally Friendly Use Period (EFUP) is 50 years

Product's Environmentally Friendly Use Period (EFUP) is 50 years

Product's Environmentally Friendly Use Period (EFUP) is 50 years

Product's Environmentally Friendly Use Period (EFUP) is 50 years

Product's Environmentally Friendly Use Period (EFUP) is 50 years

Product's Environmentally Friendly Use Period (EFUP) is 50 years

Product's Environmentally Friendly Use Period (EFUP) is 50 years

Product's Environmentally Friendly Use Period (EFUP) is 50 years

Product's Environmentally Friendly Use Period (EFUP) is 50 years

Product's Environmentally Friendly Use Period (EFUP) is 50 years

Product's Environmentally Friendly Use Period (EFUP) is 50 years

Product's Environmentally Friendly Use Period (EFUP) is 50 years

Product's Environmentally Friendly Use Period (EFUP) is 50 years

Product's Environmentally Friendly Use Period (EFUP) is 50 years

Product's Environmentally Friendly Use Period (EFUP) is 50 years

Product's Environmentally Friendly Use Period (EFUP) is 50 years

Product's Environmentally Friendly Use Period (EFUP) is 50 years

Product's Environmentally Friendly Use Period (EFUP) is 50 years

Product's Environmentally Friendly Use Period (EFUP) is 50 years

Product's Environmentally Friendly Use Period (EFUP) is 50 years

Product's Environmentally Friendly Use Period (EFUP) is 50 years

Product's Environmentally Friendly Use Period (EFUP) is 50 years

Product's Environmentally Friendly Use Period (EFUP) is 50 years

Product's Environmentally Friendly Use Period (EFUP) is 50 years

Product's Environmentally Friendly Use Period (EFUP) is 50 years

Product's Environmentally Friendly Use Period (EFUP) is 50 years

Product's Environmentally Friendly Use Period (EFUP) is 50 years

Product's Environmentally Friendly Use Period (EFUP) is 50 years

Product's Environmentally Friendly Use Period (EFUP) is 50 years

Product's Environmentally Friendly Use Period (EFUP) is 50 years

Product's Environmentally Friendly Use Period (EFUP) is 50 years

Product's Environmentally Friendly Use Period (EFUP) is 50 years

Product's Environmentally Friendly Use Period (EFUP) is 50 years

Product's Environmentally Friendly Use Period (EFUP) is 50 years

Product's Environmentally Friendly Use Period (EFUP) is 50 years

Product's Environmentally Friendly Use Period (EFUP) is 50 years

Product's Environmentally Friendly Use Period (EFUP) is 50 years

Product's Environmentally Friendly Use Period (EFUP) is 50 years

Product's Environmentally Friendly Use Period (EFUP) is 50 years

Product's Environmentally Friendly Use Period (EFUP) is 50 years

Product's Environmentally Friendly Use Period (EFUP) is 50 years

Product's Environmentally Friendly Use Period (EFUP) is 50 years

Product's Environmentally Friendly Use Period (EFUP) is 50 years

Product's Environmentally Friendly Use Period (EFUP) is 50 years

Product's Environmentally Friendly Use Period (EFUP) is 50 years

Product's Environmentally Friendly Use Period (EFUP) is 50 years

Product's Environmentally Friendly Use Period (EFUP) is 50 years

Product's Environmentally Friendly Use Period (EFUP) is 50 years

Product's Environmentally Friendly Use Period (EFUP) is 50 years

Product's Environmentally Friendly Use Period (EFUP) is 50 years

Product's Environmentally Friendly Use Period (EFUP) is 50 years

Product's Environmentally Friendly Use Period (EFUP) is 50 years

Product's Environmentally Friendly Use Period (EFUP) is 50 years

Product's Environmentally Friendly Use Period (EFUP) is 50 years

Product's Environmentally Friendly Use Period (EFUP) is 50 years

Product's Environmentally Friendly Use Period (EFUP) is 50 years

Product's Environmentally Friendly Use Period (EFUP) is 50 years

Product's Environmentally Friendly Use Period (EFUP) is 50 years

Product's Environmentally Friendly Use Period (EFUP) is 50 years

Product's Environmentally Friendly Use Period (EFUP) is 50 years

Product's Environmentally Friendly Use Period (EFUP) is 50 years

Product's Environmentally Friendly Use Period (EFUP) is 50 years

Product's Environmentally Friendly Use Period (EFUP) is 50 years

Product's Environmentally Friendly Use Period (EFUP) is 50 years

Product's Environmentally Friendly Use Period (EFUP) is 50 years

Product's Environmentally Friendly Use Period (EFUP) is 50 years

Product's Environmentally Friendly Use Period (EFUP) is 50 years

Product's Environmentally Friendly Use Period (EFUP) is 50 years

Product's Environmentally Friendly Use Period (EFUP) is 50 years

Product's Environmentally Friendly Use Period (EFUP) is 50 years

Product's Environmentally Friendly Use Period (EFUP) is 50 years

Product's Environmentally Friendly Use Period (EFUP) is 50 years

Product's Environmentally Friendly Use Period (EFUP) is 50 years

Product's Environmentally Friendly Use Period (EFUP) is 50 years

Product's Environmentally Friendly Use Period (EFUP) is 50 years

Product's Environmentally Friendly Use Period (EFUP) is 50 years

Product's Environmentally Friendly Use Period (EFUP) is 50 years

Product's Environmentally Friendly Use Period (EFUP) is 50 years

Product's Environmentally Friendly Use Period (EFUP) is 50 years